

Aluminum Door Canopy with Sidewings

Read instructions carefully prior to assembly and installation.



Door Canopy with Sidewings



Scan QR code to view assembly & installation video for this product!

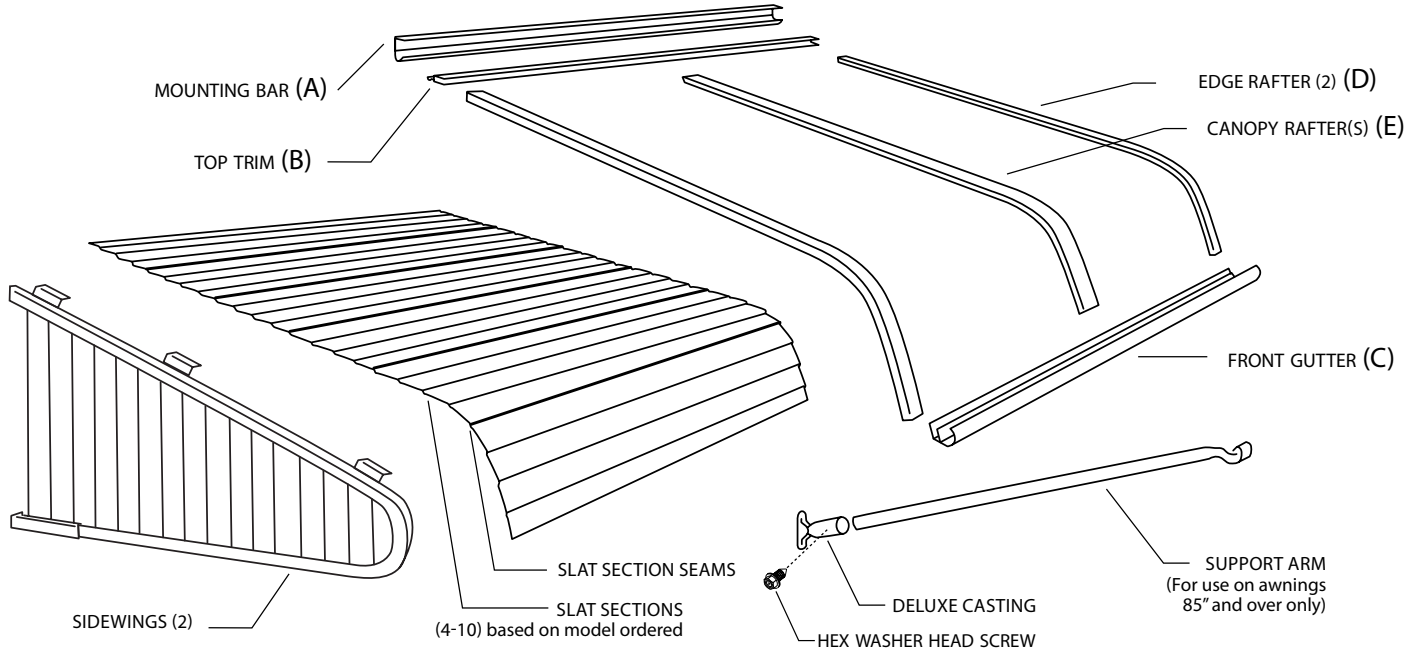

Parts Check List:

- | | | | |
|---------------------------------------|---|--|---------------------------------------|
| <input type="checkbox"/> Mounting Bar | <input type="checkbox"/> Edge Rafters (2) | <input type="checkbox"/> Support Arm (85" and over) | <input type="checkbox"/> Small Screws |
| <input type="checkbox"/> Top Trim | <input type="checkbox"/> Canopy Rafter | <input type="checkbox"/> Deluxe Casting (85" and over) | <input type="checkbox"/> Large Screws |
| <input type="checkbox"/> Front Gutter | <input type="checkbox"/> Slat Sections | <input type="checkbox"/> Interlock Clips | |

QUANTITIES & SIZE OF PARTS MAY VARY BY AWNING SIZE AND MODEL SERIES

Actual Size End Views of Door Canopy parts for easy reference and assembly:

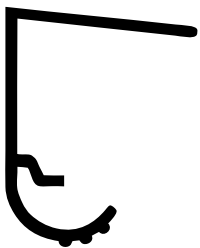

Mounting Bar (A)



Top Trim (B)



Front Gutter (C)



Edge Rafter (D)



Canopy Rafter (E)

Required Tools:

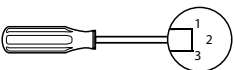

Phillips, Regular & 1/4" Hex Head Screwdrivers or Drill Bits

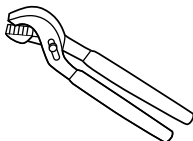

Channel Lock Pliers

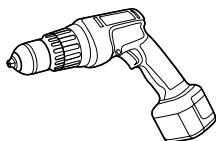

Power Drill

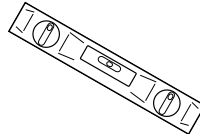

Level

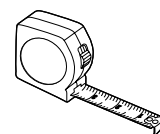

Tape Measure

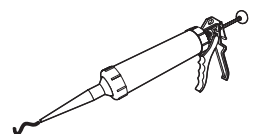

Silicone Caulk

Assembly Instructions

Aluminum Door Canopy with Sidewings

1

Slats have a slight curve to them. Keep them this way for assembly.

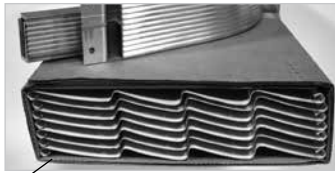

FIG. 1A



Slight curve

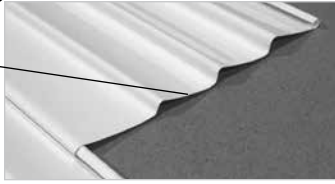

FIG. 1B

It is important that the Canopy Slats are assembled properly so that rain water will not leak through the seams where the slats join.

The canopy is assembled upside down. Note that the Slat Sections are packaged upside down (FIG. 1A). Assemble on a flat surface.

⚠ CAUTION: Canopy parts may have sharp edges. Use care in assembly.

Begin by laying the first slat out, curled edge **DOWN** on your left with ends toward you. If your canopy is colored, place the colored side down. Slide each subsequent slat into the curled **UP** edge on the right. Be sure the slats interlock properly. (FIG. 1B)

When all slats are interlocked together, the Slat Section of the Canopy is ready for the next step.

2



FIG. 2

While keeping Slat Sections **flush with each other**, crimp slats together at each seam interlock with a pair of channel lock pliers about 1/4 inch in from the edge (not too much — only enough to secure them together). Be sure to keep the plier teeth level with slats so that you do not accidentally bend them up while crimping.

3

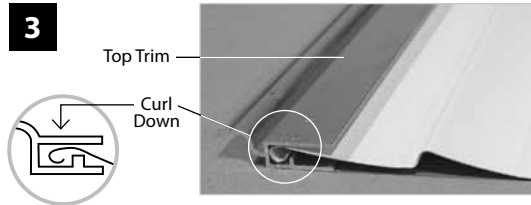

FIG. 3

Slide the Top Trim onto Slat Section end with curl **DOWN** on the left and the pre-punched holes of the Top Trim **UP**.

4

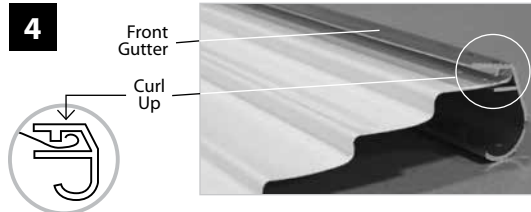

FIG. 4

At the right end or end with the curl **UP**, slide the Front Gutter onto Slat Section. Be sure to slide the Slat Sections correctly into the channel of the Front Gutter as shown. Make sure the pre-punched holes of the Front Gutter are **UP**.

5

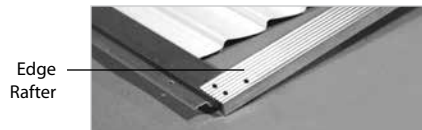

FIG. 5

TIP: Use the palm of your hand flat on slats pulling toward you to help snug them into Edge Rafter.

Slide the Top Trim out from Slat Section about 2 inches to provide clearance. Next, slide the non-curved end of the Edge Rafter into Top Trim, making sure the opposite, curved end of the Edge Rafter is up.

Next, slide both Top Trim and Edge Rafter back toward Slat Section and push Edge Rafter onto slat section edge evenly until Slat Section and the Top Trim are completely **FLUSH** into Edge Rafter.

6

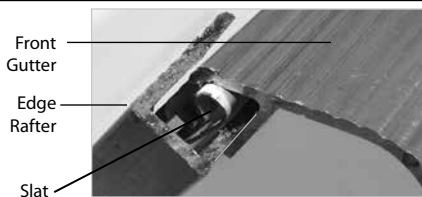

FIG. 6

NOTE: It is very important that both ends; the top trim and the front gutter ends along with the slat section are completely flush in the edge rafter to be able to align pre-punched holes for assembly.

Connect the Edge Rafter and Slat Section with the Front Gutter. Again, Slat Section and Front Gutter **MUST BE FLUSH** in the Edge Rafter. With Slat Section still secured flush in Edge Rafter, slide Front Gutter toward you and flush into the Edge Rafter, aligning pre-punched holes. It will fit snug.

NOTE: Only the outside edge of the Front Gutter and the curled edge of the slat is inserted into the Edge Rafter (FIG. 6).

Secure Edge Rafter in place. Secure Top Trim and Front Gutter with small screws in the larger pre-punched holes at each end of the Edge Rafter.

7



FIG. 7

Fasten small screws in the **two larger pre-punched holes** along Edge Rafter. (Pairs of **small holes** are for the installation of Sidewings.)

NOTE: Support the underside of the Slats Section and apply pressure while fastening screws. Repeat Edge Rafter assembly on the other side.

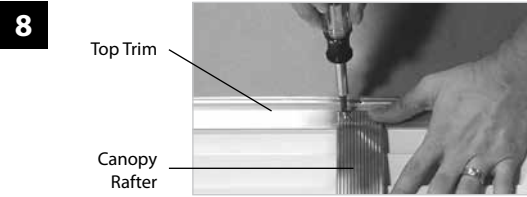

FIG. 8

Align Canopy Rafter with pre-punched holes in the center of the Top Trim first and secure with small screws. Then, repeat with the other end of the Canopy Rafter in the center on the Front Gutter and secure with small screws.

NOTE: Door canopies wider than 60" need more than one canopy rafter. Pre-punched holes will guide installation of multiple canopy rafters

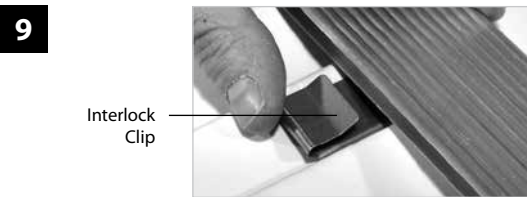

FIG. 9

Connect Canopy Slat Section to the Canopy Rafter using Interlock Clips at each joint **where the slats interlock**. Installing clips is a two-step process: (1) Insert the curved part of clip into slat joint; (2) Slide clip onto Canopy Rafter. Interlock Clips are installed on the flat section of the awning only, not at the curve. If stubborn, make sure they are straight and parallel with the slat joint.

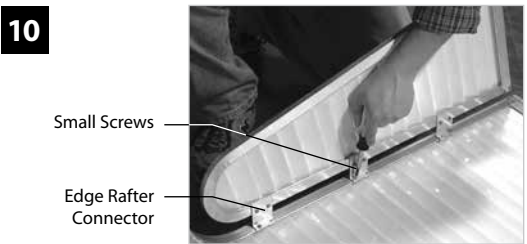

FIG. 10

Attach Sidewings to Edge Rafters with small screws using pre-drilled holes.

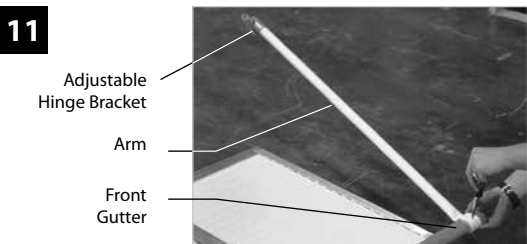
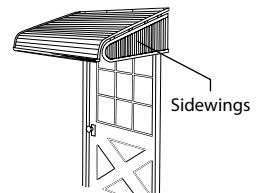

FIG. 11

NOTE: Canopies over 85" wide will include additional support arms as needed. The additional arm(s) give the canopy greater stability. They should be center mounted or as close to the center as possible.

For awnings 85" wide and over: Attach Support Arm in the center of the Front Gutter with small screws. Install Deluxe Castings to opposite ends of Support Arms and **hand-tighten** hex washer head screw. The Deluxe Castings will need readjusting and leveling when fastening to the house.



Installation Instructions

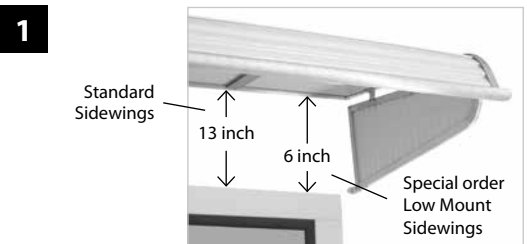

FIG. 1

Prior to installation, measure the area above your door to confirm there is sufficient space for the canopy.

NOTE: Sidewings require 13 inches of headroom over door for mounting. Special ordered Low Mount Sidewings require 6 inches of headroom for mounting.

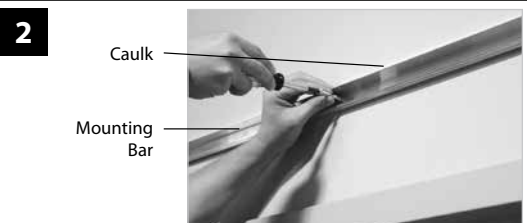

FIG. 2

Install Mounting Bar with large screws above the door. Be sure the Mounting Bar is level and centered over the opening. Screws must be in studs or heavy sheathing. (Drill alternate holes in bar if necessary).

! *Caulk the top of the Mounting Bar against the house.*

3 Lift the front of the canopy upward and insert the Top Trim into the Mounting Bar (FIG. 3A). Lower front of canopy slowly and allow Sidewings to rest on the house (FIG. 3B); be sure the two parts are completely interlocked. Secure Top Trim to Mounting Bar with small screws from bottom side (FIG. 3C).

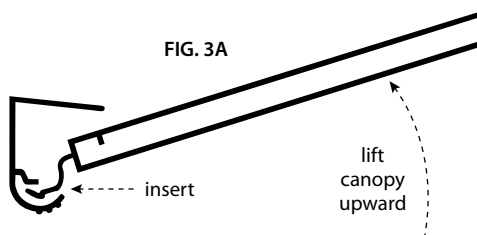

FIG. 3A

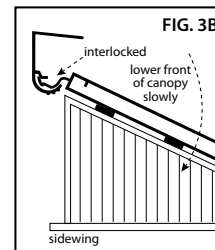

FIG. 3B

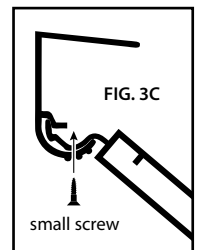

FIG. 3C

4



FIG. 4

Adjust Sidewings so they are vertically plumb. Attach Sidewings to house with large screws.

Installation of door canopy with Sidewings is now complete.

5



FIG. 5

For awnings 85" wide and over:

Adjust Support Arms for desired pitch. Be sure door opens completely before attaching. Align Deluxe Castings, level and secure to wall with large screws. Tighten hex washer head screw until flush with casting.

Installation of door canopy is now complete.

Thank you for ordering your new Aluminum Door Canopy

Nulmage Awnings® has a full line of aluminum awnings to complement your selection. Contact your local home improvement retailer, or visit www.nulmageawnings.com today to learn more about these other quality products made in the USA.

SERIES 3500



Aluminum Window Awning with Sidewings

SERIES 4500



Aluminum Casement Window Awning with Sidewings

SERIES 5500



Aluminum Roll-up Window Awning

Limited Warranty Information

Nulmage® Awnings and Canopies are manufactured by Futureguard® under the highest standards of production, after comprehensive research and development, and will be warranted by Futureguard® to the original purchaser from date of purchase for a period of Five (5) years against the occurrence of manufacturing defects directly resulting in peeling, flaking, blistering or rusting under conditions of normal use and service, subject to the terms and conditions contained in this Limited Warranty.

Futureguard® does not warrant installation nor defects caused by installation. This Limited Warranty does not cover any other defects as specified herein. This Limited Warranty does not cover any other damage or material failure resulting from, but not limited to, normal weathering, oxidation, accidental damage or intentional damage, fire or flood, windblown objects, windstorm, sleet or chemical pollutants, mildew or structural defects, negligent maintenance or misuse or abuse, or any other causes or occurrences beyond the control of Futureguard®. Under this warranty Futureguard agrees to provide material, repair, refinish, or replace at their sole option, only the parts found to be defective at no cost to the original owner. This warranty does not include any shipping or labor required to complete the warranty work.

Normal weathering may cause any surface to oxidize, chalk, gradually fade or accumulate surface dirt or stains due to varying exposures to sunlight, weather or atmospheric conditions. The geographic location, the quality of the atmosphere and other local factors in the area, over which Futureguard® has no control, contribute to the severity of these conditions.

This Limited Warranty is void if incompatible accessory products are installed which cause defects to occur.

The provisions of this Limited Warranty are the full and complete warranty policy extended by Futureguard®.

This Limited Warranty shall be null and void if harmful cleaning compounds are used.

This Limited Warranty is only valid in the 48 contiguous states.

THE WARRANTY STATEMENTS CONTAINED IN THIS LIMITED WARRANTY SET FORTH THE ONLY EXPRESS WARRANTIES EXTENDED BY FUTUREGUARD®, IN LIEU OF ALL OTHER WARRANTIES, AND THE PROVISIONS OF THIS LIMITED WARRANTY SHALL CONSTITUTE THE ENTIRE LIABILITY OF FUTUREGUARD® AND THE PROPERTY OWNER'S EXCLUSIVE REMEDY FOR BREACH OF THIS WARRANTY. FUTUREGUARD® SHALL NOT BE LIABLE TO THE PROPERTY OWNER FOR INCIDENTAL OR CONSEQUENTIAL DAMAGES OF ANY KIND FOR BREACH OF ANY EXPRESS OR IMPLIED WARRANTY.

Claim procedure and other warranty provisions. All claims for warranty must be reported in writing to Futureguard, 101 Merrow Road, Auburn, Maine 04210, Attention: Warranty Dept., within the warranty period and promptly after discovery. Describe the defect in detail and include photos, if possible together with proof of purchase. The effective warranty date shall not be increased by any such warranty work performed and the remaining warranty time shall continue in effect.

Some states do not allow the exclusion or limitation of incidental or consequential damages, so the above limitations or exclusions may not apply to you. This Warranty gives you the specific legal rights and you may also have other rights, which vary from state to state.

Snow Loads

Nulmage Aluminum Door Canopies are built from the finest components on the market today. They have been designed to withstand reasonable weather conditions including rain, sleet, snow and wind. They are NOT designed to withstand winds over 30 mph or snow loads over 12" of heavy wet snow or 24" of light snow. They will also NOT withstand the force of snow and ice dropping from an upper roof or drifting. This product has been on the market for over 50 years with an impeccable performance record when installed and used properly and within the limits for which it was developed.



www.nulmageawnings.com

Customer Service 1-800-901-3313

